

NR 1/2 E6 C

NERO Tap Range Nero Basin Taps Eco6 Chrome



Features:

- Supplied with metal handles
- Supplied with metal backnuts
- Chrome plated to BS EN 248
- Product supplied with 2 x 3 litre per minute flow regulators which can be inserted into the threaded tail to reduce water consumption and increase water efficiency (Flow Regulator accurate +/- 10%)

Product Certifications:



For more products, visit our website:
<http://www.bristan.com>



Specification

Product Type:	Bathroom Taps
Main Construction Material:	Brass
Mount Type:	Deck
Handle Type:	Lever
Connection Inlet:	1/2" BSP
Connection Outlet:	Flow Regulator
Number of Tap Holes:	2
Valve/Cartridge Type:	1/2" Ceramic Disc Valve
Plumbing System Requirements:	Suitable for all plumbing systems
Minimum Dynamic Pressure (bar):	0.2 bar
Maximum Dynamic Pressure (bar):	5.0 bar
Maximum Hot Water Temperature °C:	65°C
Maximum Static Pressure (bar):	10 bar
Isolation Included:	No

Dimensions (measurements in mm)

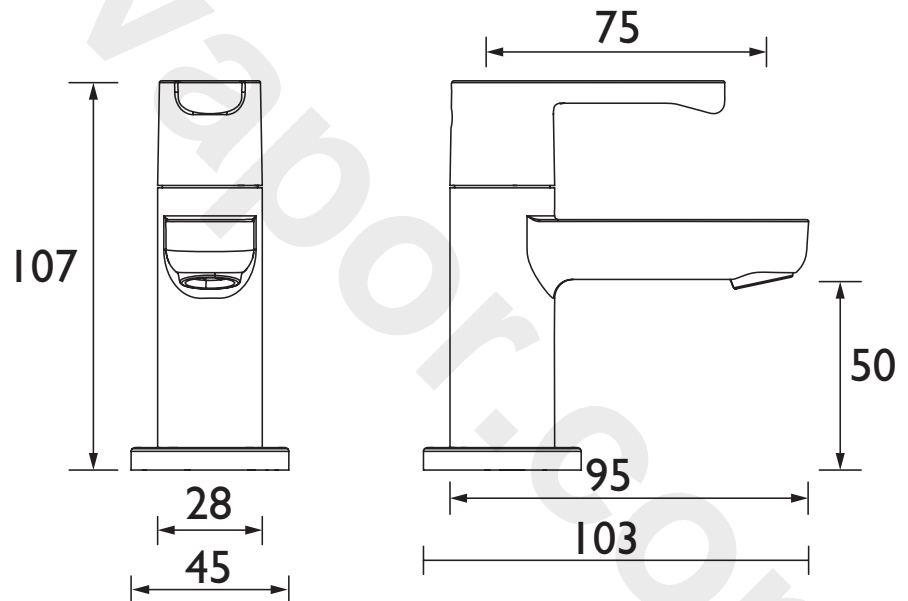

Flow Rates (l/min)

System Pressure (bar)	0.2	0.5	1	2	3	5
NR 1/2 E6 C (Cold)	3	3	3	3	3	3
NR 1/2 E6 C (Hot)	3	3	3	3	3	3

TECHNICAL DATA SHEET



BRISTAN

D5